

BG-Commander

Universal Advanced Serial and IP Joystick Controller
(IP/RS232/422)

User Manual







TABLE OF CONTENTS

Statement	3
Safety Precaution	3
Introduction	4
Features	4
Packing List	5
Specifications	5
Device Interface	5
Application Diagrams	6
Button Descriptions	8
Preset Controls	11
Joystick Controls	12
Selecting Cameras	12
Device Menu Descriptions	13
Add a Network Device	13
Add an Analog Device	13
Device List	14
Network Configuration	14
Homepage Connection and Login	17
Device Management	18
Network Settings	19
System Upgrade	20
Reset	20
Restart	20
Import Configuration	21
Export Configuration	21
Account	21
Version	21
Troubleshooting	21
Warranty	25
Copyright	26



Statement

Please read these instructions carefully before connecting, operating, or configuring this product. Please save this manual for future reference.

Safety Precaution

- To prevent damaging this product, avoid heavy pressure, strong vibration, or immersion during transportation, storage, and installation.
- The housing of this product is made of organic materials. Do not expose to any liquid, gas, or solids which may corrode the shell.
- Do not expose the product to rain or moisture.
- Do not drop the controller.
- Clean only with a soft dry microfiber cloth.
- To prevent the risk of electric shock, do not open the case. Installation and maintenance should only be carried out by qualified technicians.
- Do not use the product beyond the specified temperature, humidity, or power supply specifications.
- This product does not contain parts that can be maintained or repaired by users. Damage caused by dismantling the product without authorization from BZBGear is not covered under the warranty policy.
- Installation and use of this product must strictly comply with local electrical safety standards.



Introduction

The BG-Commander PTZ joystick controller delivers precise control for both IP and serial PTZ cameras. With high-quality backlit buttons, the BG-Commander offers a pleasing user experience - even in low-light conditions. The solid metal chassis provides a durable, stable platform, and is designed to stand up to years of heavy use, regardless of the setting. This controller is a great choice for live events, houses of worship, and broadcasting scenarios.

Features

- IP and analog control modes
- VISCA over IP, ONVIF, Pelco-P/D, and VISCA protocols
- Variable speeds for all control axes
- Zoom can be controlled by twisting the control handle or the dedicated zoom knob
- Integrated browser interface for quick setup
- Power over Ethernet (PoE) support
- Sturdy metal chassis

Packing List

- 1x BG-Commander
- 1x Power Supply
- 1x User Manual



Specifications

Parameters / Model	BG-Commander
Chip	His3536DV100
System	Linux
Protocol	VISCA, ONVIF, PELCO-P, PELCO-D, VISCA OVER IP
Output	RS422, RS232, RJ45
Beep	On/off
Power consumption	≤5W
Power	DC12V-2A
Work temperature	14°F~131°F / -10°C ~55°C
Work humidity	20%~80% frostless
Storage temperature	14°F~140°F / -10°C ~60°C
Storage humidity	0~90% frostless
Packing size	340 x 268 x 140mm
Weight	7 lbs /set

Device Interface

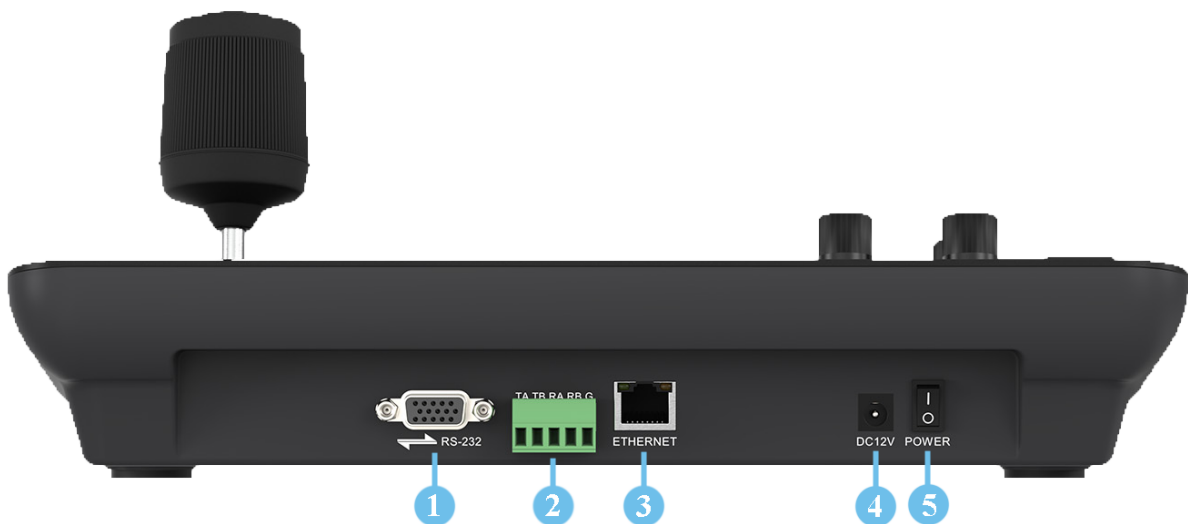

1. RS232, Supports Visca, Pelco-P/D
2. RS422/485, Supports Visca, Pelco-P/D
3. LAN Network Connection
4. Standard 5.5/2.1 power port, DC 12V2A±10%
5. Power switch on/off



Application Diagrams

1. Network connection

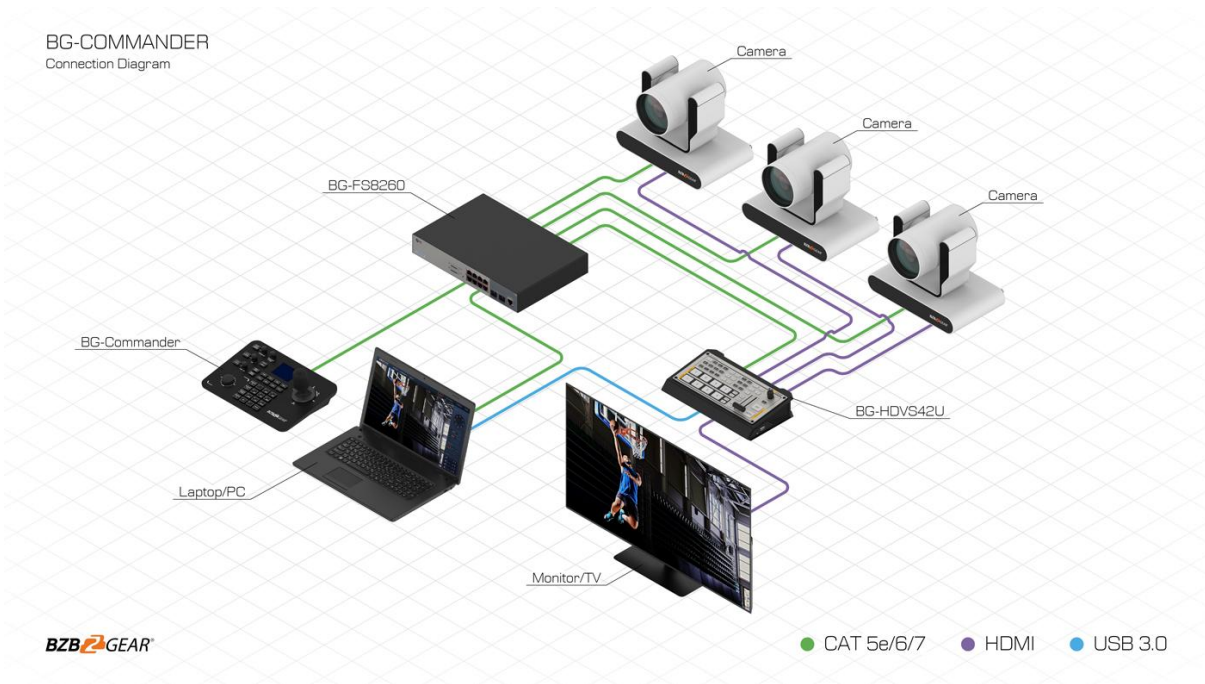

Camera and keyboard need to be connected to the LAN.

2. RS485 connection diagram

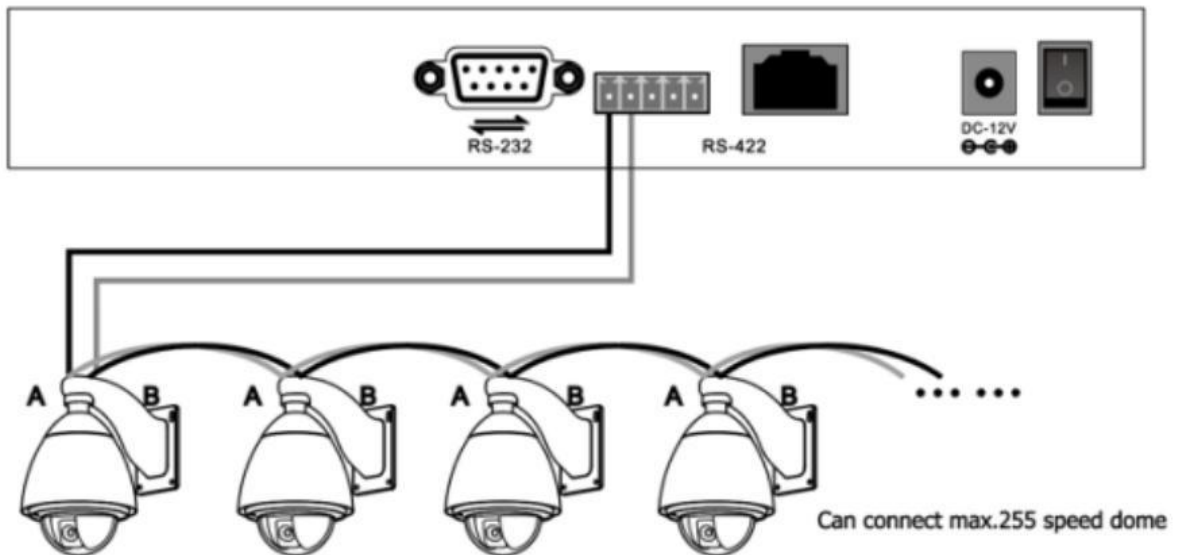

Control output:

The RS485+ of the camera is connected to the Ta of the controller, and the RS485- of the camera is connected to the Tb of the controller.



3. RS 422 connection diagram

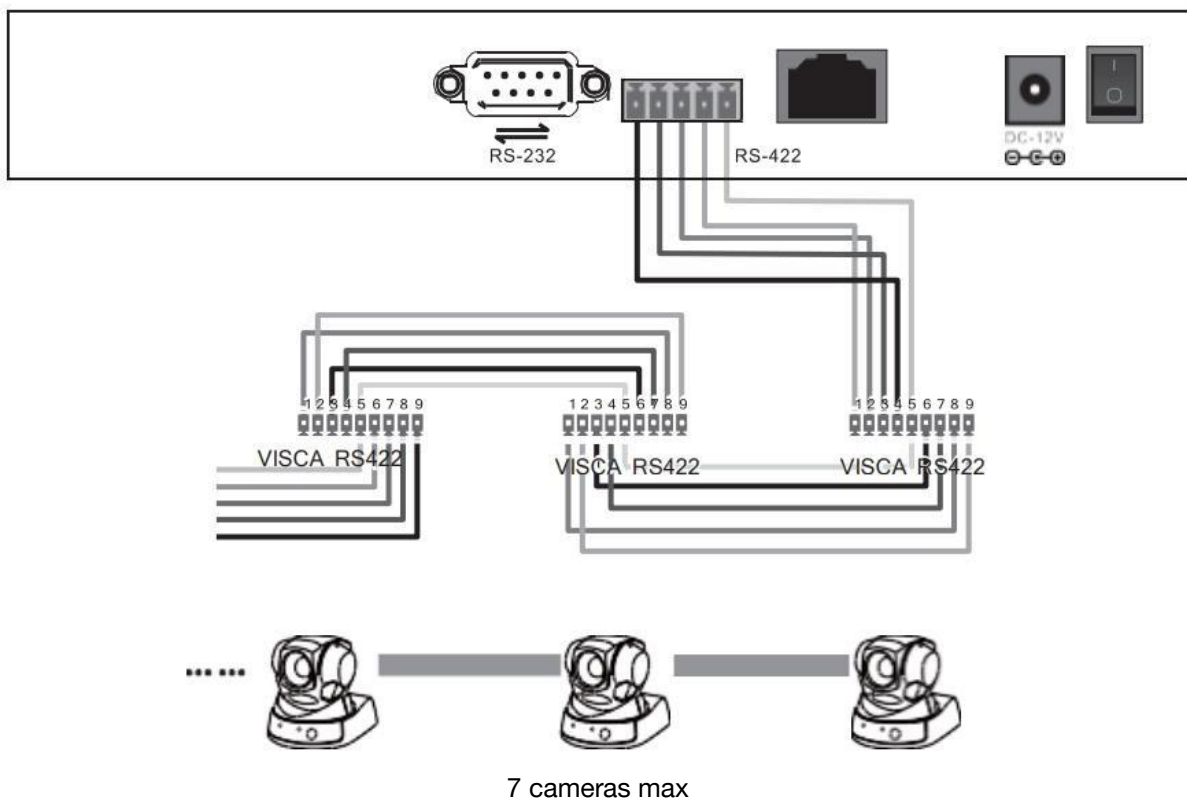

When using RS422 bus connection mode, the third pin (**Ra**) of the controller is connected to the **TXD IN-** of the camera, the fourth pin (**Rb**) of the controller is connected to the **TXD IN+** of the camera, the first pin (**Ta**) of the controller is connected to the **RXD IN-** of the camera, and the second pin (**Tb**) of the controller is connected to the **RXD IN+**

Controller	Camera
Ra	TXD IN-
Rb.....	TXD IN+
Ta.....	RXD IN-
Tb.....	RXD IN+

Using RS232 connection mode, the first pin (**RXD**) of the controller (10 Pin terminal) is connected to the camera input interface **TXD**, the second pin (**TXD**) of the controller is connected to the camera RXD, and the third pin of the controller is connected to the camera GND (you can also use the standard RS232 DB9 interface of the controller to connect the camera).

Controller	Camera
RXD	TXD
TXD	RXD
GND	GND



4. Connection between cameras

Using RS422 bus cascade connection mode, the output of camera 1 is connected to the input of camera 2, the output of camera 2 is connected to the input of camera 3, and so on. As below:

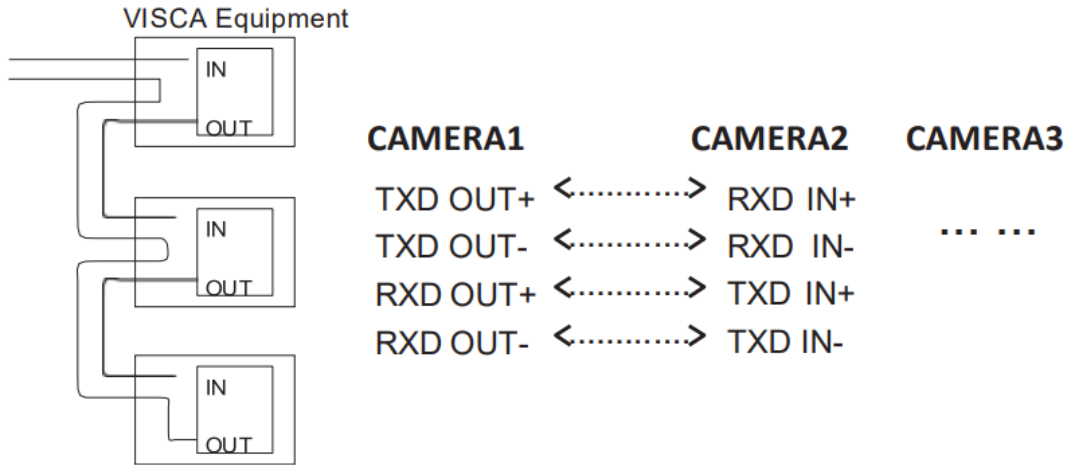

RS232 cascade connection

The output of camera 1 is connected to the input of camera 2, the output of camera 2 is connected to the input of camera 3, and so on.

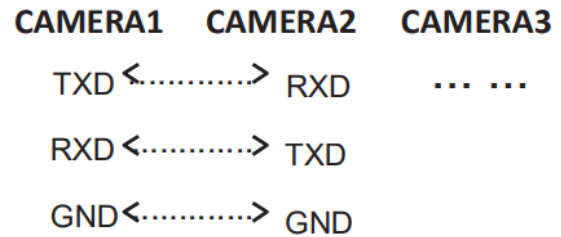



Button Descriptions



- **[AUTO WHITE BALANCE]:** When the button is illuminated red auto white balance is active.
- **[AUTO EXPOSURE]:** When the button is illuminated red auto exposure mode is active.
- **[AUTO FOCUS]:** When the button is illuminated red auto focus is active.
- **[CAM 1 - 7]:** When the button is illuminated red the selected camera can be controlled.
- **[MENU BACK]:** While in the camera OSD press this button to go back one level.
- **[MENU ENTER]:** While in the camera OSD press to confirm/advance one level.
- **[BACKLIGHT ON]:** Tap once to enable Backlight Control (BLC)
 - BG-ADAMO ONLY: Double tap to turn on Green Tally Light.
 - BG-ADAMO ONLY: Press and hold to turn on Red Tally Light.
- **[BACKLIGHT OFF]:** Tap once to disable Backlight Control (BLC)
 - BG-ADAMO ONLY: Double tap to turn off Green Tally Light.
 - BG-ADAMO ONLY: Press and hold to turn off Red Tally Light.



- **[ONE PUSH TRIGGER]:** Press to trigger white balance.
 - BG-ADAMO ONLY: Press and hold to turn off auto tracking.
- **[ONE PUSH AF]:** Press to trigger auto focus.
 - BG-ADAMO ONLY: Press and hold to turn on auto tracking.
- **[ESC]:** Exit.
- **[ENTER]:** Confirm.
- **[0-9] Number Keys:** Used to set numeric values in the menu and control presets.
- **ZOOM SPEED/PT SPEED Knob:** Zoom/PTZ speed adjustment- Turn the knob right to increase speed, left to decrease speed. Press the knob to switch the adjustment type.
- **IRIS Knob:** Adjust Exposure Turn- the knob to the right to open iris, turn left to close iris. Press **[AUTO EXPOSURE]** to enable/disable manual iris control.
- **RGAIN/BGAIN Knob:** Red/Blue gain- Turn the knob right to increase gain, left to decrease gain. Press the knob to switch the gain type. Press **[AUTO WHITE BALANCE]** to enable/disable manual color correction.
- **NEAR/FAR Knob:** Turn the knob right to adjust focus toward distant objects, turn the knob left to adjust focus toward near objects. Press **[AUTO FOCUS]** to enable/disable manual focus control.
- **Joystick Rotation:** Rotate joystick handle clockwise to zoom in, counterclockwise to zoom out.
- **Joystick Top Button:** acts as secondary Enter/Confirm
- **Zoom Knob:** Rotate knob clockwise to zoom in (telephoto), rotate counterclockwise to zoom out (wide angle)
- **[SETUP/MENU]:**
 1. Tap to enter the setup menu.
 2. Press and hold to activate the camera OSD menu.



Preset Controls

The BG-Commander can support 255 preset positions should the camera be able to support that many. To set preset and recall camera positions select the camera using the [CAM 1-7] buttons and then follow the instructions below.







Quick Access Presets 0-9

- Move the camera to the desired position using the joystick and zoom.
- Press and hold **[0-9]** number key for 3 seconds, “Preset #” will appear on screen and then disappear when the preset camera position is saved.
- To recall a preset 0-9, tap the **[0-9]** number key and the camera will move to the preset position.

Standard Presets 0-254

- Press and hold the **[Enter]** key, the LCD screen will display “LONG PRESS TO SET PRESET”, continue holding until the screen says “SET PRESET:-”.
- Use the number keys **[0-9]** to enter the desired preset number.
- Press the **[Enter]** key to save, move the joystick left to delete a number, or **[ESC]** to cancel.
- To recall a standard preset 0-254 tap the **[Enter]** key, the LCD screen will display “GOTO PRESET:-”
- Enter the preset number you wish to recall and press the **[Enter]** key to have the camera move to the preset position.

Joystick Controls

Operate	Output control	Operate	Output control	Operate	Output control
	Up		Down		Left
Operate	Output control	Operate	Output control	Operate	Output control
	Right		Zoom+		Zoom-



Selecting Cameras

Controlling Cameras 1 - 7

To select a camera to control, press the corresponding **[CAM #]** button below the LCD screen (such as **[CAM 1]**) and the button will illuminate red. The selected camera can now be controlled.

Adding Cameras 8 - 256

To control cameras that do not have a **[CAM #]** button use the following sequence to select the camera:

- 1) Press and hold the 0 key on the num pad for 3 seconds, the message "CAM ID:-" will appear on the LCD Screen.
- 2) Type in the desired camera number using the num pad and press the **[Enter]** button.
- 3) The camera will now be able to be controlled and no **[CAM #]** button will be illuminated.
- 4)

Device Menu Descriptions

Controller setting	Description	
1. Add network device	Camera	The joystick ID of a camera can be 1-256; press [ENTER] to save.
	Protocol	Optional: VISCA (UPD), SONY VISCA (UDP), VISCA (TCP), ONVIF, select the corresponding protocol of the camera.
	IP address	Camera IP address.
	Port	Input the camera port number.
2. Add analog device	Camera	The joystick ID of an analog camera can be 1-256, press [ENTER] to save.
	Protocol	Select the protocol corresponding to the camera.
	Address code	Select the address code corresponding to the camera.
	Baud rate	Select the baud rate corresponding to the camera.
3. Device list	The list of added cameras can be reviewed by moving the joystick up and down. Press the button on the top of the joystick or press [ENTER] to confirm.	
4. Network properties	Network properties	Switch through the options by moving the joystick left and right, press [ENTER] to confirm.
	Dynamic (DHCP)	Dynamic IP allocation based on switch settings.
	Static	Manually enter IP address information for the controller.
5. Device Language: EN/Chinese	Switch through the options by moving the joystick left and right, press [ENTER] to confirm.	
6. Key tone	Switch through the options by moving the joystick left and right, press [ENTER] to confirm.	
7. Reset	Double press [ENTER] to reset, press [ESC] to cancel.	
8. System information	View the controller software, hardware, web version, gateway and subnet mask.	



Add a Network Device

Use the controller to add a LAN devices as follows:

1. Press the **[SETUP/MENU]** key to enter the main menu.
2. Select Add Network Device and press the **[ENTER]** key.
3. Fill in the camera (1-7), protocol, IP address, port, username and password (if required), and press **[ENTER]** to save.

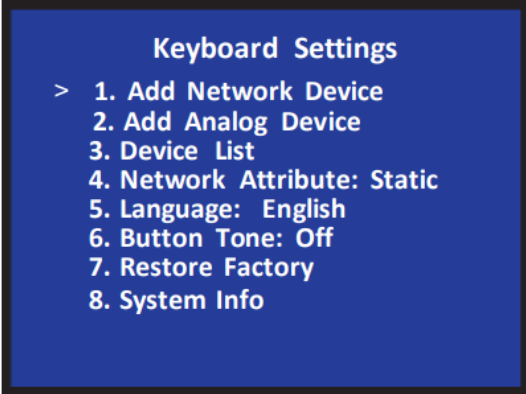

Add an Analog Device

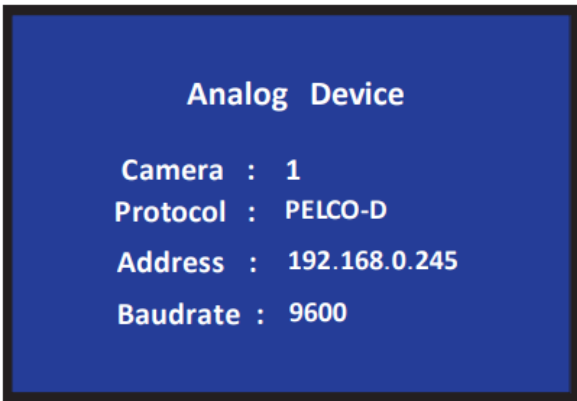
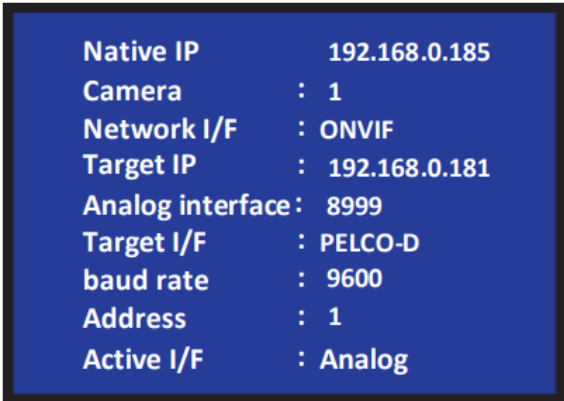

1. Long press the button on top of the joystick handle to switch the analog mode.
2. Press **[SETUP/MENU]** button to enter the setting interface, select to add analog device.
3. Enter the device adding interface, select the camera with 1-7 digital number, select the corresponding analog protocol, select the address code corresponding to the camera, select the baud rate, and press **[ENTER]** to confirm the addition.



Device List

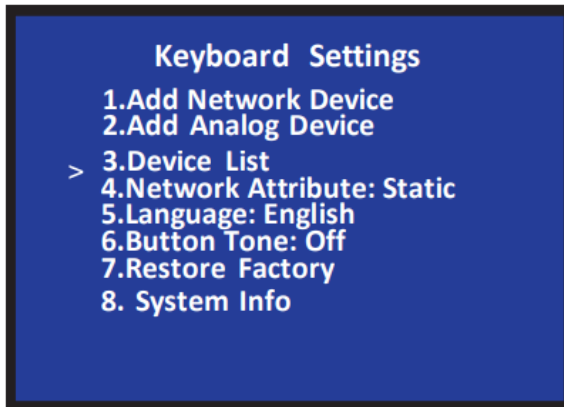

1. Press the **[SETUP/MENU]** button to enter the settings interface, move the joystick up and down to select option 3 Device List press the **[ENTER]** button to view the added devices.
2. Review the saved devices by moving the joystick up and down, press the button on top of the joystick handle or the **[ENTER]** button to select the camera to be controlled.
3. When the screen shows that the connection is successful, the controller has been connected to this IP device and can be controlled.



Network Configuration

The computer must be on the same subnet as the controller to connect successfully. The device will not be accessible otherwise. The controller **default IP address is 192.168.5.180**, therefore the computer must also be connected to the 192.168.5.x subnet.

To connect to the controller, open the Local Area Connection Properties on the computer.

For Windows 10 users right-click on the internet connection in the lower right corner of the desktop.

Select **“Open Network & Internet Settings.”**

Select **“Change Adapter Options.”**

Right-click on your connection (Wi-Fi or Ethernet) and select **“Properties.”**

Select **“Internet Protocol Version 4 (TCP/IPv4)”** as shown below and click **“Properties.”**

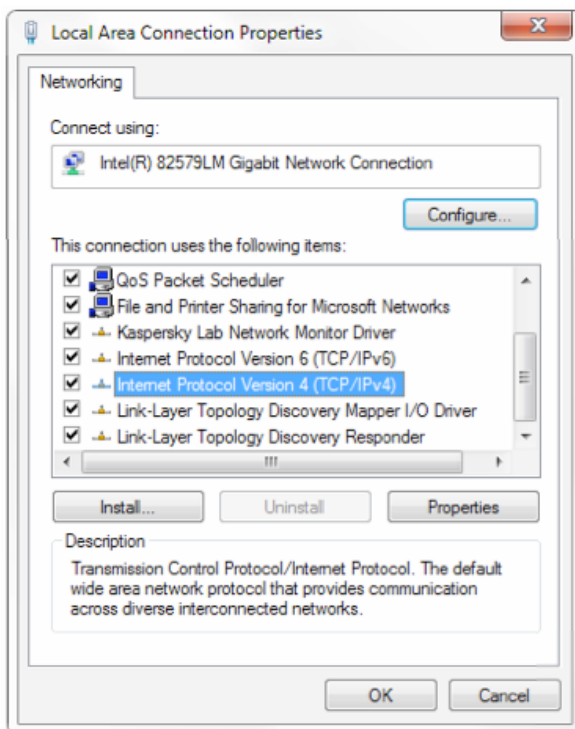



For the following steps refer to the diagram below.

Click on the bubble for **“Use the following IP address”**

In the **IP address** field enter a non-conflicting IP address on the same subnet as the camera. If there is another device with the same IP address you will not be able to connect. In the example below we are using 192.168.5.200

In the **Subnet mask** field enter 255.255.255.0

In the **Default gateway** field type 192.168.5.1

You can leave the DNS fields blank.

Click **OK** to apply your settings.

NOTE: When you are finished configuring the camera you will need to return to this screen and click the bubbles for **“Obtain an IP address automatically”** and **“Obtain DNS server automatically”** to restore internet connectivity to your computer. Also make sure to reconnect any ethernet cables you may have unplugged.

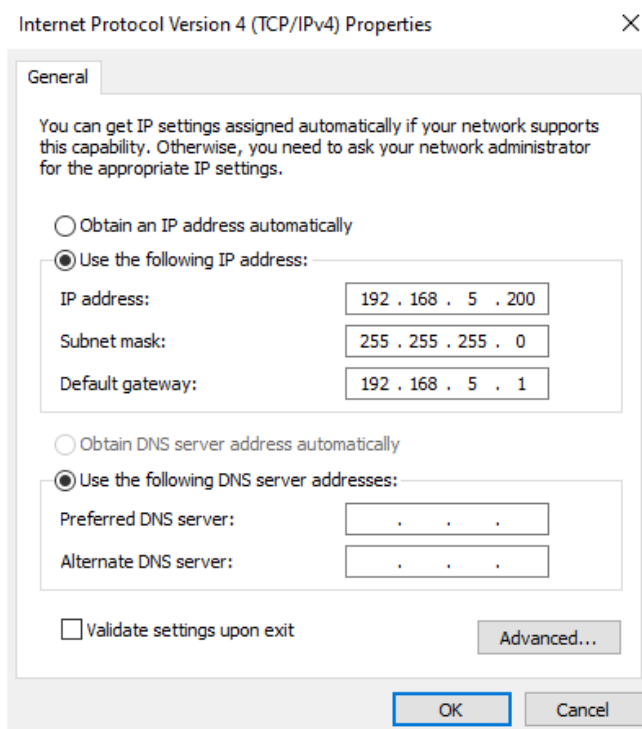



Homepage Connection and Login

Connect the power cable of the controller and connect a network cable (**NOTE:** only the network cable is needed if connected to a PoE switch).

After the controller boot sequence is complete, the BG-Commanders' IP address will be displayed on top of the screen as the "NATIVE IP."

Default login information

Username: admin

Password: none



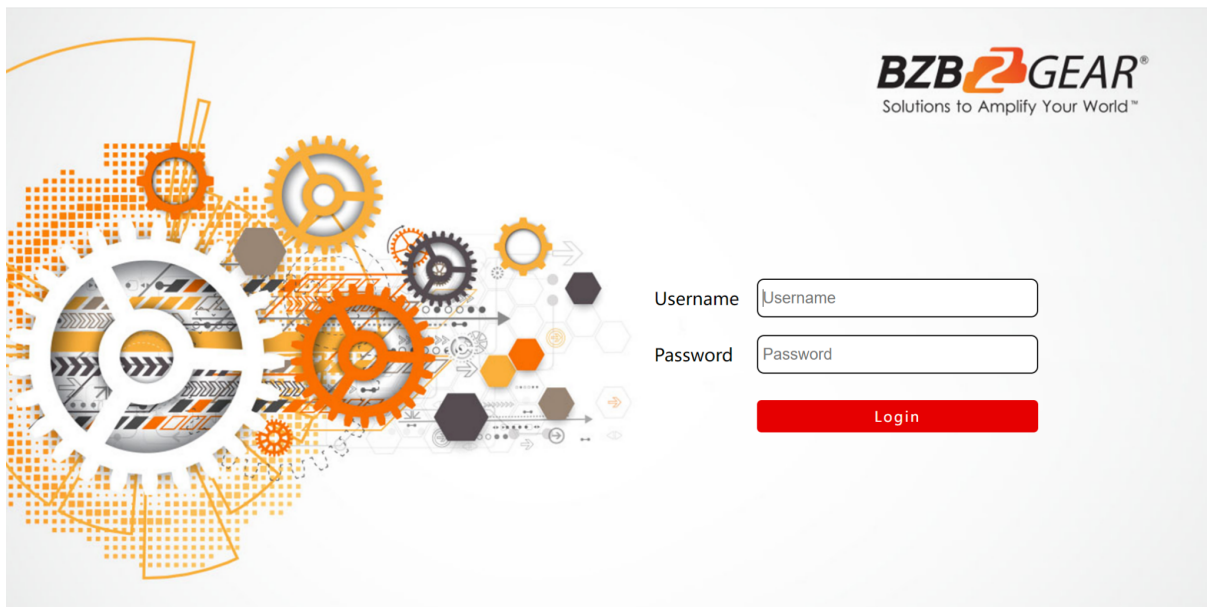



1. Connect the controller and computer to the same network. Enter this IP address into your web browser to access the configuration page (shown below) and enter the default credentials.





Device Management

On the “Device Management” tab click  button to add or edit PTZ cameras 1 - 7 connected to the controller. Depending on the connection from the controller to the camera one section, Network or Analog, will need to be configured (see below).

<input type="checkbox"/>	Camera	IP	Port	Protocol(network)	Baudrate	Address	Protocol(analog)	Edit
<input checked="" type="checkbox"/>	1	192.168.30.188	1259	VISCA(UDP)	1200	1	VISCA	
<input type="checkbox"/>	2	192.168.30.47	1259	VISCA(UDP)	1200	2	VISCA	
<input type="checkbox"/>	3		0	UNKNOWN	0	3	UNKNOWN	
<input type="checkbox"/>	4		0	UNKNOWN	0	4	UNKNOWN	
<input type="checkbox"/>	5		0	UNKNOWN	0	5	UNKNOWN	
<input type="checkbox"/>	6		0	UNKNOWN	0	6	UNKNOWN	
<input type="checkbox"/>	7		0	UNKNOWN	0	7	UNKNOWN	

Batch Edit << 1/1page >>

Edit
✕

Camera:

Network:

Protocol ▾

IP

Port

Analog:

Protocol ▾

Baudrate ▾

Address

Save

Network:

1. Select the camera protocol
2. Enter the camera IP address
3. Enter the camera port

Analog:

1. Select the camera protocol
2. Select the camera baudrate
3. Enter the camera address

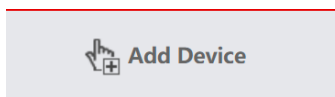

To add cameras 8 - 256 press the  button in the top left of the interface.

Use the “Batch Edit” or “Batch Delete” buttons to edit or delete multiple selected cameras.



Network Settings

LAN settings of the controller can be modified by clicking the Settings Tab and then selecting Network from the left-hand menu.

The screenshot displays the Network Settings configuration page. The left-hand navigation menu includes 'Network', 'Upgrade', 'Reset', 'Restart', 'Import', 'Export', and 'Version'. The 'Network' section is active, showing the following configuration details:

- Network Type:** STATIC (selected from a dropdown menu)
- IP Address:** 192.168.30.164
- Netmask:** 255.255.255.0
- Gateway:** 192.168.30.1
- DNS1:** 8.8.8.8
- DNS2:** 8.8.4.4

A red 'Save' button is positioned at the bottom right of the configuration area.

Network Type: Can be set to DHCP or Static.

DHCP: DHCP is off by default, but when enabled, the controller will be automatically assigned an IP address from the network if a DHCP server is present. (**NOTE:** The other fields cannot be configured and are grayed out)

STATIC: Enter a user defined IP Address, Netmask, and Gateway.

NOTE: After any changes are made you must click the “Save” button, the controller will restart, and you will be redirected to the login screen.



System Upgrade

The upgrade tab is used for performing firmware updates. Select “Browse” to locate the correct upgrade file and then click “Upgrade.” After the upgrade is complete, the device will automatically restart.

NOTE: Do not perform any operations on the device during its upgrade and do not power off or disconnect from the network.

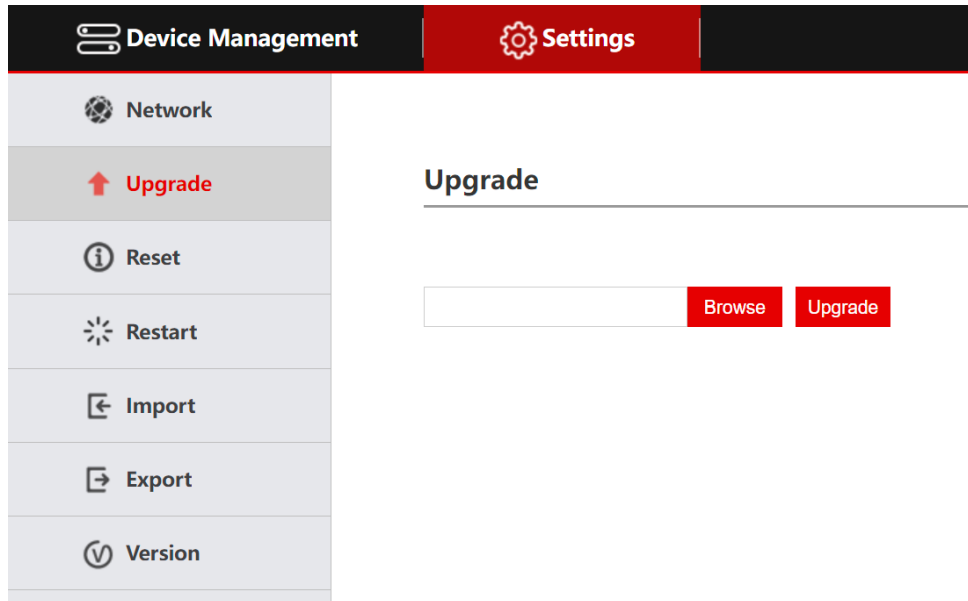



Reset

Click “Reset” to restore the device to factory settings and clear all added devices.

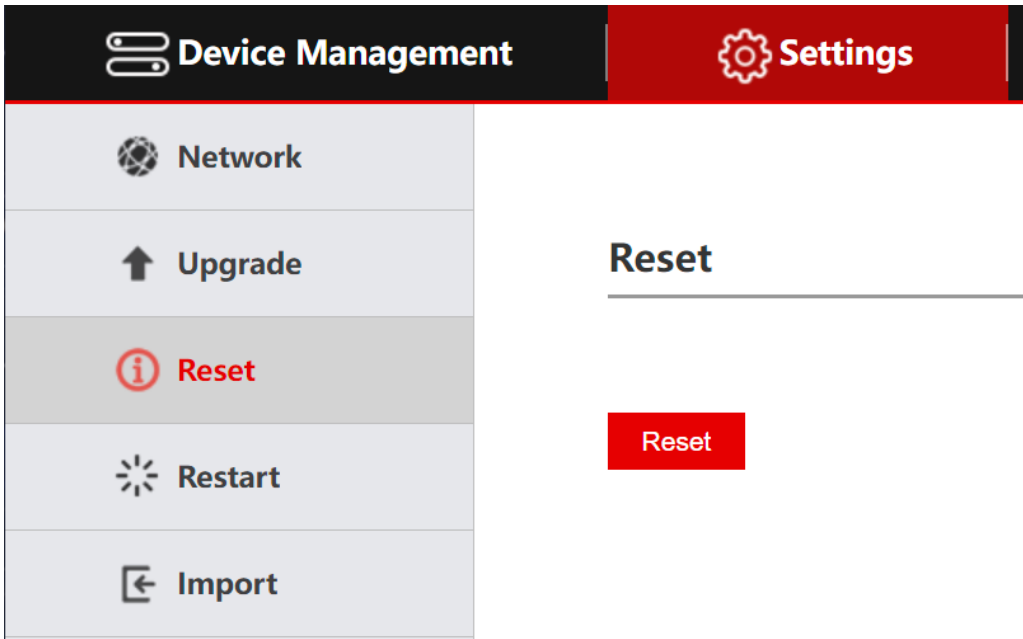

Restart

Click “Restart” to perform a system reboot of the controller.

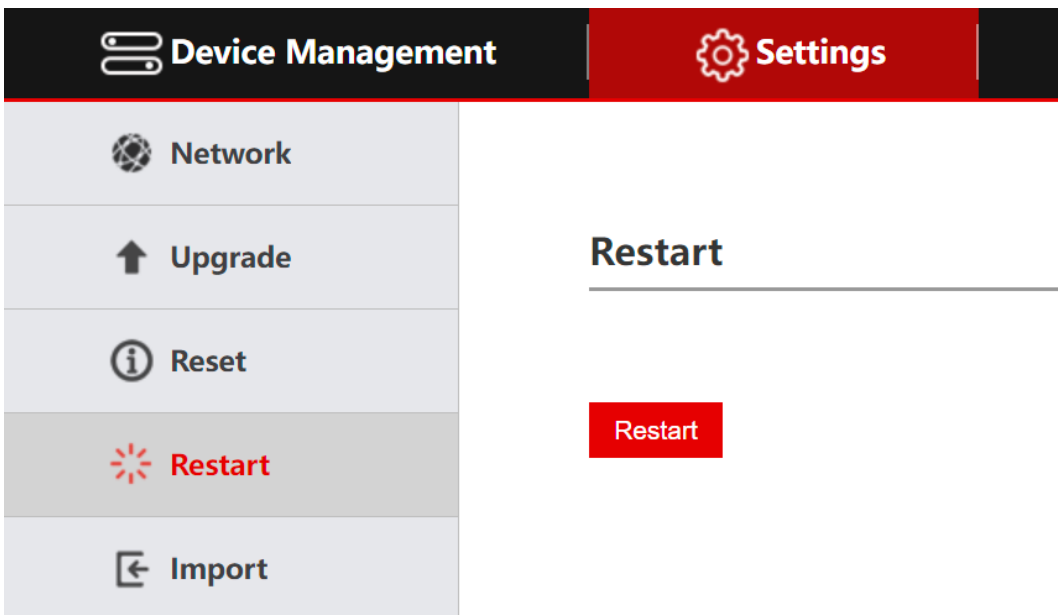



Import Configuration

Import a previous configuration.

The screenshot shows the 'Settings' page in the BZBGear BG-Commander interface. The left sidebar contains a menu with options: Network, Upgrade, Reset, Restart, Import (highlighted in red), and Export. The main content area is titled 'Import' and features a text input field followed by 'Browse' and 'Import' buttons.

Export Configuration

Export the information of the current controllers' added devices and can be imported to other controllers.

The screenshot shows the 'Settings' page in the BZBGear BG-Commander interface. The left sidebar contains a menu with options: Network, Upgrade, Reset, Restart, Import, and Export (highlighted in red). The main content area is titled 'Export' and features a single 'Export' button.



Account

Modify, Add, or Remove user accounts for the web interface.

The screenshot shows the 'Settings' menu with 'Account' selected. On the left is a sidebar with options: Network, Upgrade, Reset, Restart, Import, Export, Account (highlighted), and Version. The main content area displays a table of user accounts:

<input type="checkbox"/>	ID	Username	Password <small>🔒</small>	Modify
	1	admin		

Below the table are two red buttons: 'Add' and 'Delete'.

Version

Display the software and hardware information of the current controller.

The screenshot shows the 'Settings' menu with 'Version' selected. On the left is a sidebar with options: Network, Upgrade, Reset, Restart, Import, Export, and Version (highlighted). The main content area displays the 'Version' section with the following information:

- Hardware: V0.0.1_190823
- Software: V5.0.9_20221110L
- Web: V3.0.6_200827



Troubleshooting

1. If the screen displays "Connection failed", check that IP information is correct for the camera. Verify the controller and camera are on the same subnet.
2. If the screen displays "Username and password are incorrect", please check whether the added device username and password are correct.
3. If the camera does not respond to the joystick while in VISCA UDP mode enter the controller setup menu and set option 9: VISCA RESPONSE to DISABLE.

Tech Support

Have technical questions? We may have answered them already!

Please visit BZBGear's support page (bzbgear.com/support) for helpful information and tips regarding our products. Here you will find our Knowledge Base (bzbgear.com/knowledge-base) with detailed tutorials, quick start guides, and step-by-step troubleshooting instructions. Or explore our YouTube channel, BZB TV (youtube.com/c/BZBTVchannel), for help setting up, configuring, and other helpful how-to videos about our gear.

Need more in-depth support? Connect with one of our technical specialists directly:

Phone

1.888.499.9906

Email

support@bzbgear.com

Live Chat

bzbgear.com



Warranty

BZBGEAR Pro AV products and cameras come with a three-year warranty. An extended two-year warranty is available for our cameras upon registration for a total of five years.

For complete warranty information, please visit bzbgear.com/warranty.

For questions, please call 1.888.499.9906 or email support@bzbgear.com.



Mission Statement

BZBGear is a breakthrough manufacturer of high-quality, innovative audiovisual equipment ranging from AVoIP, professional broadcasting, conferencing, home theater, to live streaming solutions. We pride ourselves on unparalleled customer support and services. Our team offers system design consultation, and highly reviewed technical support for all the products in our catalog. BZBGear delivers quality products designed with users in mind.



Copyright

All the contents in this manual and its copyright are owned by BZBGear. No one is allowed to imitate, copy, or translate this manual without BZBGear's permission. This manual contains no guarantee, standpoint expression or other implies in any form. Product specification and information in this manual is for reference only and subject to change without notice.

All rights reserved. No reproducing is allowed without acknowledgement.